

# solo<sup>®</sup>

## SPRAYERS

*built to last a lifetime*

### OPERATOR'S MANUAL & PARTS LIST 425, 475, 425D, 425LC



If you are missing parts, instructions or have questions, **DO NOT** take this unit back to the store. Call 1300 798 022. Solo will send the missing parts/information to you promptly.

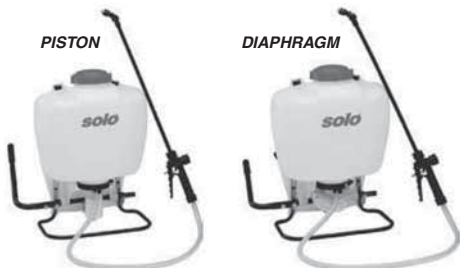

#### WARRANTY

Solo backpack sprayers are covered by Solo's WARRANTY (5 years for models 425 & 475, 2 years for Model 425D, 425 LC). Solo manufactured parts which fail due to defective material or workmanship will be repaired or replaced without charge. Refer to Warranty sections for consumer and commercial use, of this Owners Manual, for full details.

#### MAINTENANCE TIP

Cap gasket is pre-lubricated for improved sealing. Occasional lubrication is recommended.

#### SAFETY PRECAUTIONS

1. Before using sprayer with chemicals, fill sprayer with fresh water to assure that you have it properly assembled; pressurize and practice spraying.

Also, check for any leaks at this time. When thoroughly familiar with the sprayer operation, follow normal operating procedures.

2. Ensure all pressure in the sprayer is relieved by locking the shut-off valve in the open position.
3. Avoid contact with chemicals.
4. Always wear rubber gloves, safety goggles and appropriate protective clothing.
5. Work in a well ventilated area.
6. Individuals should be trained in the proper use of this sprayer, chemical handling procedures, and first aid/emergency care. Where training is not available, individuals should study and follow the procedures detailed in this manual.

Chemicals can be harmful to individuals and the environment if improperly used. In addition, some chemicals are caustic, corrosive or poisonous and should be avoided. Read warnings and chemical manufacturers' instructions. Solo high density polyethylene sprayers are fitted with Viton<sup>®</sup> seals which are resistant to a wide variety of agricultural and household chemicals; however, care should be exercised to ensure that sprayer components are clean, functioning properly, and in a good state of repair before and during use.

If in doubt about a particular chemical, check with the manufacturer. If you suspect or observe indications that the material may be unsafe in a Solo sprayer...**STOP. DO NOT USE OR APPLY CHEMICAL. ALWAYS WEAR RUBBER GLOVES, GOGGLES, AND APPROPRIATE PROTECTIVE CLOTHING!**

Read and follow operating instructions:

- Do not fill with, use, or spray flammable materials.
- Do not modify sprayer.
- Never spray in the direction of humans, animals or property which might be injured or damaged by spray formula.
- Do not use disinfectants, solvents or impregnating agents unless first tested to ensure they are not harmful to the environment or sprayer.
- Do not use liquids with a temperature above 43°C.
- Wear appropriate protective clothing to prevent contact with chemical agents.
- Rinse and clean sprayer thoroughly after using. Disposal of contaminated rinse should be in accordance with applicable ordinances. Observe the precautionary instructions of the chemical manufacturer.
- **DO NOT USE ANY ACID (INCLUDING CITRUS), PETRO CHEMICALS OR CAUSTIC CHEMICALS (including bleach).**
- Remember that a sprayer with liquid is a significant amount of weight (15kg per 15 litres). Use caution when bending, leaning or walking. Bend at the knees rather than the waist.
- During sprayer operation, the pressure cylinder (44 00 240) contains compressed air and liquid. Compressed air and liquid under pressure are inherently dangerous. Before making adjustments on sprayers fitted with a pressure regulating valve body (40 74 323) or control knob (40 74 344) located on the pressure cylinder or any other repair or inspection of any sprayer, be sure to relieve pressure through the shut-off valve and wand.

**CUSTOMER SERVICE COMMITMENT FROM SOLO'S SERVICE DEPARTMENT:** In the event the sprayer you have purchased has missing or damaged parts, please call 1300 798 022, 9:00am – 5:00pm Mon-Fri. In order to assist your service representative, please have the following information available: sprayer model number, part description and part number. A parts list is included in your operator's manual. Solo is committed to your satisfaction and is continuing its efforts to earn your future business.

Visit us on the web at [www.soloaustralia.com.au](http://www.soloaustralia.com.au) Troubleshooting and parts ordering available on-line.

## REMOVING THE NOZZLE

Unscrew the nozzle cap (1) from the nozzle body (3). This is best accomplished while the retaining nut (2) is fastened tightly to the elbow (5). Next, unscrew the retaining nut (2). Push the nozzle body (3) out of the retaining nut (2). The filter with gasket (4) will come out with the body. To reinstall the nozzle, reverse the above instructions. (Plastic adjustable nozzle used as a example. Details of all Spray Tip Assemblies are shown on the next page)

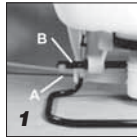

## SHOULDER STRAP INSTALLATION

The top of the shoulder straps are pre-attached to the sprayer by means of a buckle. The lower end of the straps are attached by fastening the strap hooks to the metal frame between where frame exits the plastic tank and makes a bend.

## REGULATING THE PRESSURE

(FOR 425 & 475 MODELS ONLY)

The Solo backpack sprayer is equipped with a built-in regulator to control output pressure. This regulator is operator adjustable. Make adjustments prior to filling tank. To adjust the regulator, remove the tank cap and the filter basket. Look inside the spray tank; you will see the top of the regulator. There are 4 fingers on the regulator knob. The finger farthest to the left is 1; to the right is 4. They are numbered 1, 2, 3, 4. 1 = 15 psi, 2 = 30 psi, 3 = 45 psi, 4 = 60 psi. The higher the pressure, the more chemical applied from the sprayer in a given amount of time, but the droplets will be smaller with more drift. If the spray pressure must be changed, excess pressure in the pressure cylinder must be released back into the tank through the spray tube.

## ASSEMBLY INSTRUCTIONS FOR WAND

1. Insert wand into shut-off valve as shown.
2. Tighten the screw cap clockwise onto the shut-off valve.

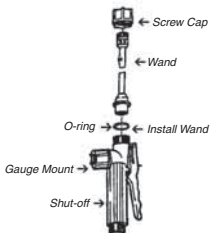

## PUMP LEVER INSTALLATION

(MODEL 425D, 425LC ONLY)

All hardware necessary for pump lever installation is included with the sprayer. The pump lever (C) should be installed as follows: place lever handle (C) onto the shaft (A). Align bolt holes and install the two bolts (E) and washers (F); then tighten. To install pump lever on the opposite side, remove the stop plate (D) and washer, install the pump lever as above. The stop plate (D) should be mounted on the inner bolt hole with the closed end of the stop plate pointing downward on the opposite side of the pump shaft.

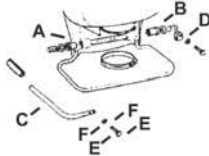

## FOLD-AWAY PUMP HANDLE INSTALLATION (FOR 425 & 475 MODELS ONLY)

1. Remove bolt and nut (A) from pump rod (B).
2. Slide handle assembly over the pump rod and align the holes so that the rear (elbow) portion of the handle points up and slightly forward and away from the Solo logo. Reinstall bolt and locknut. Pump handle can be installed on the opposite side of the sprayer for right hand pumping. (Stop plate will need to be relocated to the left side.)
3. The handle can be rotated to either down (pumping) or up (storage) positions.

**Note:** The handle swings away from the sprayer, then up or down as desired. The spray wand attaches to the clamps on the handle assembly for storage (does not apply to the brass wand).

Setting	PSI
1	15
2	30
3	45
4	60

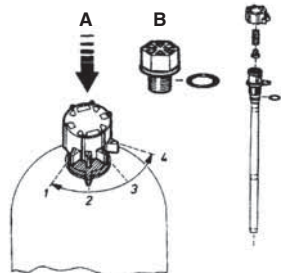

To adjust, push down on the knob and rotate to align the desired number with the alignment pin. To operate the Deluxe Models at higher than 60 psi, first release the excess pressure and then replace the adjustment piece with the optional plug (42 00 215).

## FILLING

Mix the spray formula and the proper volume of water in a separate container. Pour the mix through the filter basket in the tank opening. This keeps debris from entering sprayer.



**Note:** To fill the sprayer to its full capacity, set the pressure control valve to the 3 or 4 setting. (425 & 475 models only) Add 10 litres of spray formula mix. Pump the sprayer handle to prime the pump and fill the pressure cylinder. The volume of liquid in formula mix tank will appear to decrease as the pressure cylinder is filled. Liquid will flow through the top of the pressure regulator when the cylinder is completely full. Add the remaining formula mix to the tank.

Remember that it's not necessary to completely fill the sprayer tank each time. Mix only the amount needed to get the job done.

Always read and follow manufacturer's instructions printed on the product label. This can save money and help prevent crop and environmental damage.

## OPERATING FEATURES

Nozzles – Your Solo sprayer is supplied with nozzle arrangements to provide a variety of spray patterns.

Item		Application	Part
Flat spray nozzle		Row treatment	40 742 631
Jet stream nozzle		Spot & longer range	40 74 755
Jet stream nozzle and Swirl plate = hollow cone		Shrubs and bushes	40 74 755 40 74 756

## SPRAY TIP ASSEMBLY

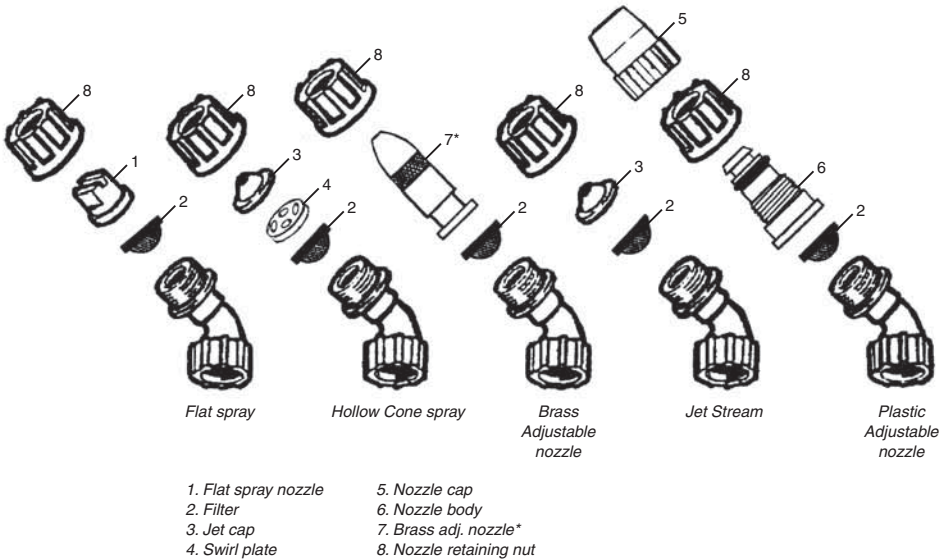

\*The Brass Adjustable Nozzle and Plastic Adjustable Nozzle are not a standard supply with the Solo backpack sprayer. Spray tips should be assembled as above for desired spray pattern.

## SPRAYING

Prime the pump with rapid pump strokes. When you feel very firm resistance, the pressure chamber is filling with liquid.

With repeated piston strokes, the air in the pressure chamber is slowly compressed. By pressing the hand lever, the valve opens, and liquid is forced through the nozzle. The shut-off valve has a retaining clip which keeps the valve in the "OPEN" position for continuous operation. Pump using the end of the pump handle, as it is less fatiguing. The volume of liquid delivered varies with the working pressure which should be as high as needed to ensure an adequate spray pattern for each individual application.

**Note:** Should the pressure drop very quickly, drain the tank completely and pump without liquid. By this procedure, the air chamber is refilled with the required volume of air. It is advisable to pump the tank completely empty from time to time.

## WETTABLE POWDERS & MARKER DYE

Avoid use in piston pump sprayers models 425, 425D & 425LC. The Solo models 475 sprayers with a diaphragm pump are generally resistant to abrasive materials and are recommended for this purpose.

**Note:** If you use a wettable powder in your 425 sprayer, be sure it is thoroughly mixed in the formula solution.

Immediately after use, be sure to remove the piston, clean and lubricate the Viton® collar with petroleum jelly. Thorough flushing of sprayer will extend the life of its working parts. If you use wettable powders in the piston pump sprayer, be sure to inspect regularly for seepage around the piston and repair accordingly.

## CLEANING

- After spraying, clean the tank thoroughly. If some spray liquid is left inside, drain tank completely.
- Pumping causes air to be taken in and the remaining liquid to be discharged. Pump until liquid and air are coming out through the nozzle.
- Refill tank with a few litres of clean water and pump the water out as explained above (if necessary, repeat this procedure several times).
- If the Lance is removed, the pump can be flushed quickly. Improper spray distribution is the result of a clogged nozzle, which is easily removed and cleaned.
- Soap and water may also be used to clean tank.
- Do not use aggressive cleaning agents or abrasives.
- Follow the recommendations of the chemical manufacturer for disposal of waste water and chemicals.
- Activated charcoal in liquid or other form may be used to absorb chemicals in tanks or spills.

**NOTE:** When cleaning the sprayer after working with hormone weed killers, follow the instructions of the herbicide producers. Neutralize with activated charcoal. (Example: add 1g. of activated charcoal to 1 liter of water and leave this detergent in the tank and the lines approximately for 24 hours.) This is very important if other chemicals should be sprayed as the residues of the herbicide may damage susceptible plants. Cleaning after application of products containing carbolineum, if they are not water soluble, should be done with a 3% soda lye having a temperature of 40°C. Rinse with plenty of clean water.

## MAINTENANCE AND STORAGE TIPS

To protect the piston, cylinder and Vitor® collar, a fine mesh, stainless steel screen is located on the pressure cylinder inlet.

If you find that your sprayer will not empty the formula tank, check for a clogged inlet screen (2). The inlet screen is located at the bottom of the pressure cylinder on the side that faces your back.

One indication that it needs cleaning is that when you let go of the pump handle, it "springs" to the down position.

The screen can be cleaned with a small bristle brush or a discarded toothbrush. See diagram for location of screen.

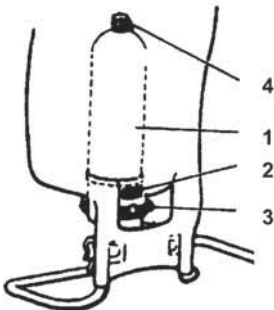

1. Pressure Cylinder
2. Inlet Screen
3. Pump Clamp
4. Pressure Control Valve (425 & 475 Models Only)

- After operation, the sprayer should be stored away from direct sunlight to prevent UV damage.
- After removing the pump or when mounting a new Vitor® collar, treat both the collar and the piston with water resistant grease.\*
- Before winter, drain all liquid in tank, lines and air chamber. (See "Cleaning.") Leave shut-off valve locked in the "open" position.

- For service, visit our website to locate your nearest Solo dealer. Always insist on original Solo spare parts.
- Regularly inspect hose, wand, pump, tank and shut-off valve for wear, damage or leaks. Repair promptly.
- Occasionally lubricate cap gasket.\*

Avoid excessive wear by:

1. Regular lubrication of Vitor® collar, cylinder and piston with water resistant grease.\*
2. Prompt and thorough cleaning and flushing of sprayer. Soap and water work well.

\*Use Petroleum jelly.

## SOLO WARRANTY

Solo Australia warrant the product from the date of purchase, for a period as stated below. The warranty covers manufacturer's defects in material or workmanship. The warranty does not cover malfunctions due to misuse or due to failure to follow the instructions in this manual. Any alterations to the product are to be performed by a Solo Australia approved service agent. Any repairs performed by non approved personnel may void the warranty.

To make a claim, contact Clayton Engineering, 26 French Ave, Brendale, Q, 4500 on phone 1300 798 022 or email sales@claytonengineering.com.au. You will be asked to provide proof of purchase and then will be instructed on the procedure for repairing or replacement of the product under warranty. All costs incurred for repair or replace, and additional claims can be discussed at this stage.

This warranty is provided in addition to other rights and remedies you have under law: Our goods come with guarantees that cannot be excluded under the Australian Consumer Law. You are entitled to a replacement or refund for a major failure and for compensation for any other reasonably foreseeable loss or damage. You are also entitled to have the goods repaired or replaced if the goods fail to be of acceptable quality and the failure does not amount to a major failure.

## CONSUMER WARRANTY

Solo equipment purchased for consumer use is covered by this Warranty for a period of 5 years (Models 425 & 475) and 2 years (Model 425D & 425LC).

## COMMERCIAL WARRANTY

Solo equipment purchased for commercial use is covered by this Warranty for a period of 2 years (Models 425 & 475) and 6 months (Model 425D & 425LC).

## ITEMS NOT COVERED BY WARRANTY

Provisions of the Warranty will not apply to the following:









Normal service requirements arising during the warranty period, such as cleaning, normal wear, lubrication, filter, spray tips, etc. Normal service work over and above the repair or replacement of defective parts.

Any failure that results from an accident, customer abuse, normal wear, neglect or failure to operate the product in accordance with the instructions provided in the operator's manual or provided with the product. When an alteration or modification has been performed on a Solo product, Solo is responsible only for products as originally furnished by Solo, provided the alterations or modifications do not adversely affect the product's operation, performance or durability. Parts or accessories that are incompatible with the product are not approved by Solo.

Full disclosure of Solo's Warranty is available from your local Solo dealer or SOLO Australia.

## ACCESSORIES

The following accessories are not standard. Order them from your SOLO dealer.

	<p><b>Pressure Control Gauge (49 00 356)</b>  <i>Displays spraying pressure so operator can maintain desired pressure level.</i></p>
	<p><b>Brass Adjustable Spray Nozzle (49 00 207)</b>  <i>Affords operator a full range of sprays from fine to jet stream.</i></p>
	<p><b>Drift Guard (49 00 430)</b>  <i>Helps control application of formula under breezy conditions.</i></p>
	<p><b>4-Nozzle Spray Boom (49 00 299)</b>  <i>Mounted on the back part of the sprayer frame or attached to brass spray lance with flat spray nozzles for area treatment (total width 125cm; distance between nozzles 40.5cm).</i></p> <p><b>Mounting Kit (49 00 517)</b></p>
	<p><b>2-Nozzle Spray Boom (49 00 514)</b>  <i>Handheld spray boom mounts on end of spray wand (total width 84cm; distance between nozzles 61cm). Includes 2 flat spray nozzles.</i></p>
	<p><b>Twin Nozzle (49 00 477)</b>  <i>This is a multi-purpose nozzle that attaches to the end of the spray wand for double row application.</i></p>
	<p><b>Brass Spray Wand (49 00 528)</b>  <i>The spray wand is 150cm long and replaces the standard spray tube for treating trees up to heights of 5 meters. Additional extension tube available in 50cm length (49 00 513).</i></p>
	<p><b>Shoulder Saver Harness (43 00 343)</b>  <i>Heavy duty padded straps, padded lumbar support and fully adjustable straps.</i></p>

In the best interest of continued technological progress, we reserve the right to change design and configuration of any product without prior or other notice. Therefore, please note that text and illustrations of this manual are not to be considered binding and do not constitute a basis for legal or other claims.

**Note:** An order form is provided on the back pages of this manual.

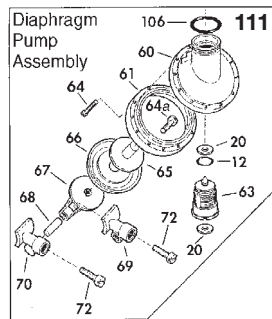
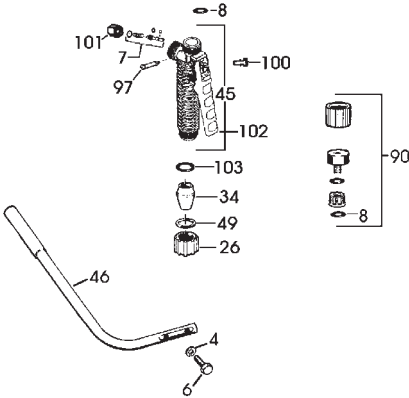
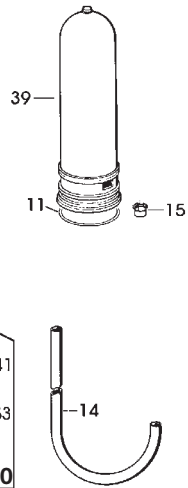
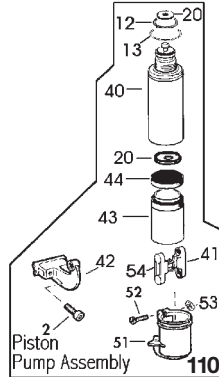
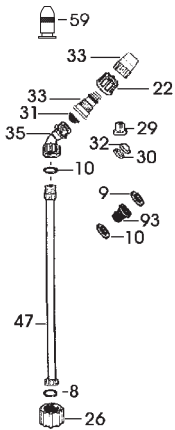
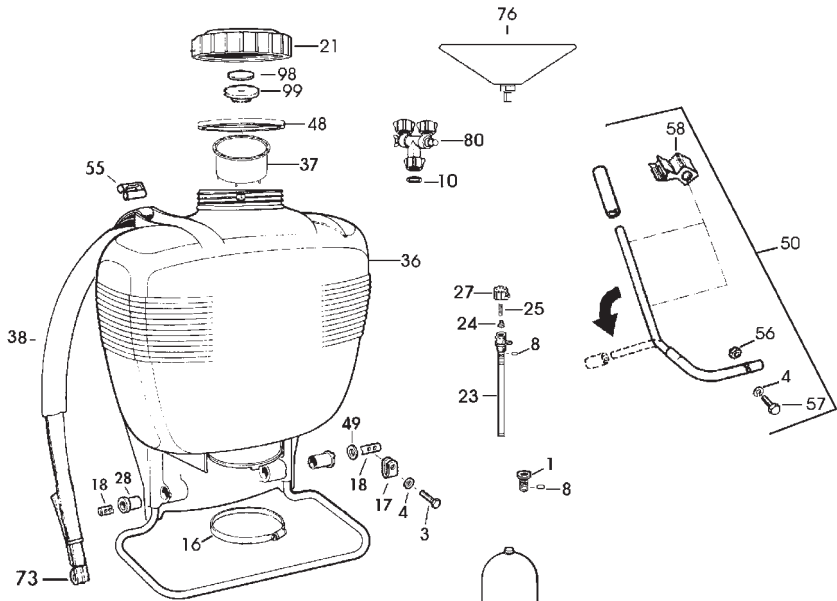

POS. NO.	ORDER NO.	DESCRIPTION
<b>425, 475, 425D &amp; 425LC SPARE PARTS</b>		
1	42 00 215	Plug (item 8 incl.)
2	00 10 165	Bolt
3	00 12 185	Bolt
4	00 30 131	Washer
6	00 12 185	Bolt
8	00 62 258	Gasket
9	00 62 106	O-ring
10	00 62 115	O-ring
11	00 62 291	O-ring
12	00 62 139	O-ring
13	00 62 140	O-ring
14	00 64 234	Hose
15	00 66 388	Hose clamp
16	00 66 394	Clamp
17	40 43 123	Stop plate
18	40 35 111	Pump shaft
20	40 61 257	Valve plate
21	42 00 242 25	Red tank cap (item 48, 98 & 99 incl.)
22	40 74 148	Retaining nut
23	40 74 323	Valve body
24	40 74 350	Sealing piece
25	00 70 260	Compression spring
26	40 74 337	Retaining nut
27	40 74 344	Control knob
28	40 74 410	Bushing
29	40 74 2631	Flat spray jet
30	40 74 756	Swirl plate
31	40 74 283	Jet filter
32	40 74 755	Nozzle Cone
33	49 00 527	Plastic adjustable nozzle (Inc. a & b)
34	40 74 500	Clamp
35	40 74 527 25	Elbow
36	42 00 279	Tank and frame assy., 15 litre.
37	42 00 166	Filter basket
38	43 00 340	Carrying strap (item 73 incl.)
39	44 00 240	Pressure cylinder
40	44 00 1681	Cylinder assy. (item 12, 13, 20 incl.)
41	40 74 409	Connecting rod without stud
42	40 74 262 25	Lever
43	40 73 558 25	Piston
44	44 00 189	Vitor® collar
45	48 00 170-P	Shut-off valve, assy.
46	48 00 173 25	Pump lever (item 75 incl.)
47	49 00 391	Spray tube
48	40 61 345	Gasket
49	00 31 356	Washer
50	49 00 454	Fold-away handle (item 58 incl.)
51	40 74 680	Protective cover
52	00 10 110	Bolt
53	00 20 101	Hex. nut
54	40 74 408	Connecting rod with stud
55	40 74 412	Buckle
56	00 20 119	Nut
57	00 12 192	Bolt

POS. NO.	ORDER NO.	DESCRIPTION
58	40 74 996	Clip
59	49 00 207	Brass adjustable nozzle (Inc. a & b)
60	40 73 411	Housing (diaphragm)
61	40 73 410	Flange
63	44 00 222	Valve assy. (item 12 & 20 incl.)
64a	00 18 257	Screw
65	40 74 256	Diaphragm plate
66	40 74 245	Diaphragm
67	40 74 255	Connecting rod
68	40 31 130	Wrist pin
69	40 74 234	"R" connecting bracket
70	40 74 243 25	"L" connecting bracket
72	00 10 141	Bolt
73	40 74 833 25	Hook
93	40 74 922	Filter
97	40 74 295	Pin
98	40 61 464	Vent plate
99	40 74 123	Vent cap
100	40 74 329	Lock clip
101	40 74 336	Retaining nut
102	40 74 335	Lever
103	00 62 271	O-ring
106	00 62 140	O-ring
<b>425, 475, 425D, 425LC ACCESSORIES</b>		
33 & A	49 00 527	Plastic Adjustable Nozzle
59 & A	49 00 207	Brass Adjustable Nozzle
A	06 10 408-P	Elbow & Nozzle Set
80 & A	49 00 477	Double Spray Nozzle
F	49 00 230-P	PVC Spray Wand 50cm + Nozzle
F	49 00 513	PVC Extension Wand 50cm
F	49 00 449	Carbon Tree Lance 120cm
F	49 00 457	Carbon Telescopic Wand 60-120cm
F	49 00 445	Carbon Telescopic Wand 120-230cm
F	49 00 450	Flexible Spray Tube
F	49 00 519	Brass Spray Wand 50cm
F	49 00 428	Brass Spray Wand 75cm
F	49 00 528	Brass Tree Lance 150cm
F	49 00 478	Brass Telescopic Wand 57-100cm
E	49 00 514	2-Nozzle Mini Boom
E	49 00 299	4-Nozzle Spray Boom
E	49 00 517	Mounting Kit for 4-nozzle boom
76 & B	49 00 430	Drifter Guard - Large
B	49 00 626	Drifter Guard - Small
C	43 00 343	Heavy Duty Harness
90	49 00 356	Pressure Gauge for Hand Piece
45	48 00 170-P	Hand Piece Assembly
93	27 00 316	Ball Valve Filter
—	49 00 600	Sprayer Cleaner 500ml
<b>425, 475, 425D &amp; 425LC REPAIR KIT</b>		
110	44 00 203	Pump Assembly – Piston
111	44 00 221	Pump Assembly – Diaphragm
—	06 10 407-K	425/425D/425LC Repair Kit
—	06 10 406-K	475 Repair Kit
7	06 10 402-K	Hand Piece Repair Kit 425/475/425LC
7	06 10 402D	Hand Piece Repair Kit 425D

## INSTALLATION INSTRUCTIONS

### PISTON PUMP REPAIR KIT (06 10 407-K)

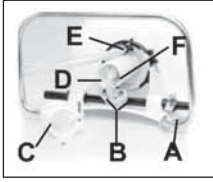

Figure 1.



Figure 2.



Figure 3.

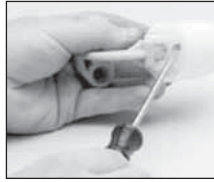

Figure 4.



Figure 5.



Figure 6.



Figure 7.



Figure 8.



Figure 9.



Figure 10.

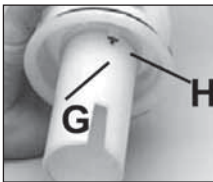

Figure 11.



Figure 12.

**Note:** Always wear rubber gloves, safety goggles and appropriate protective clothing when repairing a sprayer. Work in a well-ventilated area. Prior to repair, flush unit with water by filling, then spraying the water into an appropriate container or area. Ensure that all pressure is released by locking the shut-off valve in the open position. Once a repair is completed, fill the unit with clean water, pressurize, and check for leaks. If the sprayer leaks, DO NOT USE. Repair leaks and recheck.

#### Tools needed for kit installation

6mm Allen Head Wrench, Flat Screwdriver, 11mm Wrench or Crescent Wrench, Long Nose Pliers, Hammer, 13mm Socket or Wrench, T-25 Torx Screwdriver, Grease or Petroleum Jelly, 2X4 Piece of wood 45.72cm long

- Using a 13mm socket wrench remove the handle bolts, and set aside. Lay unit on its back with pump assembly facing you. See figure 1. Loosen hose clamp (E). Pull off sprayer hose. **Caution:** There may be liquid inside the hose and pressure cylinder even when the tank is empty. Wear protective gloves. Next, remove the nut and bolt from protective cap, and remove cap (C). Loosen stop plate (A) but do not remove. Rotate the pump shaft to access the two lever bolts in the center (B). Using a 6mm allen head wrench, remove them. Pull the piston (F) out of the piston cylinder (D).
- To remove the piston cylinder assembly, turn the cylinder counter clockwise when viewing from the bottom. Figure 2. **Caution:** The piston cylinder has sharp edges.
- Check the inside of the piston and cylinder for scratches. If the piston or cylinder are scratched, replace.
- To remove connecting rods from the piston and lever, insert a flat tip screwdriver between the two connecting rods and twist.
- With the new piston, place the two connecting rods over the studs on the inside of the piston. Place the lever studs into the connecting rods and snap together with your fingers.
- To replace the Vitor® collar, push it off the top of the piston with your thumb. Figure 6. Install the new collar on the piston onto the form fitted sides.
- Remove the valve plate and O-rings from the outside of the piston cylinder. Install the new valve plate and the two O-rings making sure the O-rings seat in the grooves. Finally, inside the piston cylinder you will find a second valve plate. Using needle nose pliers, pull out the red or orange pin and remove the valve plate. Install a new valve plate and firmly reseal the retaining pin using needle nose pliers. Do not push pin hard up against valve plate.
- If necessary remove the pressure cylinder by unscrewing the pressure regulator control, if equipped. Remove the large clamp at the bottom of the cylinder. Use a block of wood and hit forcefully with a hammer, driving the assembly through the bottom of the tank.
- Next, assemble the piston cylinder. First grease the O-ring on the piston cylinder, being careful not to get any on the valve plate, and then place the piston cylinder into the pressure cylinder. Screw the piston cylinder clockwise until it is tight and the bottom O-ring is no longer seen. When properly seated the notch on the piston cylinder (G) will line up with the indent on the pressure cylinder (H).
- Apply a light coat of grease to the inside of the piston cylinder wall and on the Vitor® collar, and then re-install the piston into the piston cylinder. Figure 12. To insert the piston, tilt at a slight angle with the leading edge of the Vitor® collar placed over the slot. When seated, install the 6mm Allen Head bolts through lever base into shaft.

Replace the protective cap and tighten the nut and bolt. Reinstall the handle. Re-tighten the stop plate, making sure the bolt goes through the rear hole. Replace the hose and black hose clamp making sure it is firmly secured.

Re-tighten the stop plate, making sure the bolt goes through the rear hole. Replace the hose and black hose clamp making sure it is firmly secured.



# INSTALLATION INSTRUCTIONS

## DIAPHRAGM PUMP REPAIR KIT (06 10 406-K)

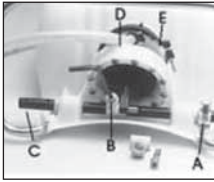

Figure 1.

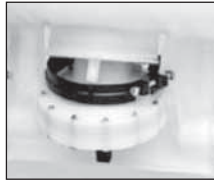

Figure 2.



Figure 3.

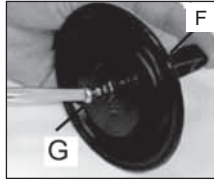

Figure 4.



Figure 5.

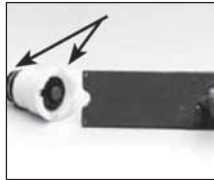

Figure 6.

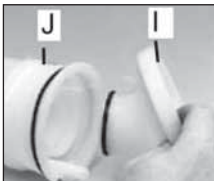

Figure 7.

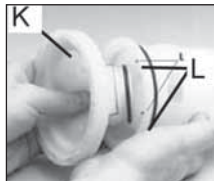

Figure 8.

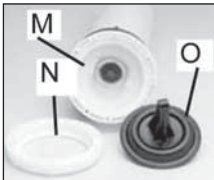

Figure 9.



Figure 10.

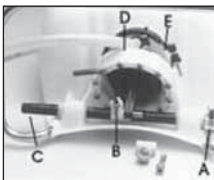
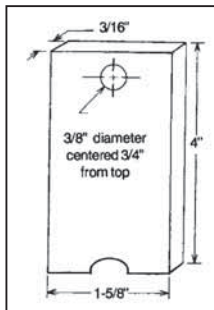

Figure 11.



**Note:** Always wear rubber gloves, safety goggles and appropriate protective clothing when repairing a sprayer. Work in a well ventilated area. Prior to repair, flush unit with water by filling, then spraying the water into an appropriate container or area. Ensure that all pressure is released by locking the shut-off valve in the open position. Once a repair is completed, fill the unit with clean water, pressurize, and check for leaks. If the sprayer leaks, DO NOT USE. Repair leaks and recheck.

Tools needed for kit installation: 6mm Allen Head Wrench, Flat Screwdriver, 11mm Wrench or Crescent Wrench, Long Nose Pliers, Hammer, 13mm Socket or Wrench, T-25 Torx Screwdriver, Grease or Petroleum Jelly, 2X4 Piece of wood 45.72cm long

1. Using a 13mm socket wrench, remove handle bolts and loosen the stop plate (A) and remove the two allen head screws (B) that hold the connecting pieces to the pump rod.

2. With unit laying on its back with pump assembly facing you, remove the pump rod (C). Loosen hose clamp and remove pressure hose (D). Next, loosen the clamp at the base of the sprayer (E). Figure 2.

3. Push the pressure cylinder approximately 2.54cm out of the bottom of the tank. Then turn the pump assy. 180° degrees.

**Note:** Wooden block may be used to tap the pump assembly through bottom of tank.

Remove pressure regulating valve, if equipped before removal of cylinder.

4. Next remove the 12 torx screws that hold the flange in place. The flange and diaphragm can then be removed. Figure 3.

**Note:** For clarity the pressure cylinder is shown removed from the tank.

5. To replace the diaphragm, remove the connecting rod retaining screw (G) from the plunger and lever (F). Replace the diaphragm and reassemble. See Figure 4.

6. The valve assy. (H) is removed using a locally made tool. Remove red valve plate retaining pin using needle nose pliers, then insert tool into slots. See Figure 5. Use a screwdriver to rotate tool counter clockwise.

7. Once the valve assembly is removed, the valve plates and O-rings can be replaced. The bottom valve plate is secured into place with a red retaining pin. Push pin into place using needle nose pliers. Figure 6.

8. The pump housing (I) is separated from the pressure cylinder (J) by pulling it off. Figure 7. The O-ring can then be replaced.

9. When reassembling the pump housing to the pressure cylinder, be sure the square tab on the pump housing (K) is aligned in the notch. See arrows (L) on the pressure cylinder in Figure 8. Be careful not to pinch or nick the O-ring.

**Note:** Grease O-rings for re-assembly. Screw the valve assembly into the cylinder.





10. Place diaphragm assembly (O) onto the pump housing (M). Place the flange (N) over the diaphragm. Reinstall the 12 torx screws around the outside diameter of the flange.

11. Push pressure cylinder into the tank being careful not to pinch the large O-ring (P).

**Note:** Wooden block may also be used for installation of the pressure cylinder.

12. Tighten pump clamp securely (E). Install pump rod (C). Reinstall the connecting pieces and allen head screws (B). Reinstall the stop plate (A) making sure that the bolt goes through the rear hole. Reinstall the hose and hose clamp making.

## NOZZLE TIP SPECIFICATION

Description	Order number	Spray Volume		Pressure		Angle	Applications
		1/min.	gal/min.	atu atm	psi		
<b>Flat Spray Nozzle</b>	40 74 2631 Red	0.88	.23	1.0	15	120°	area and row treatment 
		1.25	.33	2.0	29	120°	
		1.53	.40	3.0	44	120°	
<b>Flat Spray Nozzle</b>	40 74 501 Yellow	0.65	0.172	2.0	29	80°	
		0.80	0.211	3.0	44	80°	
		0.92	0.243	4.0	59	80°	
<b>Adjustable Nozzle</b> Brass Plastic	49 00 207	1.53	0.40	2.8	40	Straight stream	tree spraying (adjustable spraying pattern)
	49 00525	0.76	0.20	2.8	40	Hollow Cone	
<b>Hollow Cone Nozzle</b> 1mm orifice	40 74 755* Black	0.4	0.10	1.0	15		shrubs, bushes 
		0.55	0.15	2.0	29		
<b>Hollow Cone Nozzle</b> 1.4mm orifice	40 74 758 Grey	0.64	0.17	1.0	15	50°	
		0.91	0.24	2.0	29	65°	
		1.11	0.29	3.0	44	65°	
<b>Hollow Cone Nozzle</b> 1.8mm orifice	40 74 726 Blue	0.88	0.23	1.0	15	55°	
		1.25	0.33	2.0	29	70°	
		1.53	0.40	3.0	44	72°	
<b>No-drift Nozzle</b> AN 1.0	40 74 385 Yellow	0.28	0.07	0.4	6	100°	mainly for herbicides a low pressure
		0.38	0.10	0.7	10	100°	
		0.46	0.12	1.0	15	100°	
<b>No-drift Nozzle</b> AN 2.0	40 74 386 Red	0.55	0.15	0.4	6	100°	
		0.76	0.20	0.7	10	100°	
		0.91	0.24	1.0	15	100°	
<b>No-drift Nozzle</b> AN 2.5	40 74 514 Brown	0.72	0.19	0.4	6	110°	
		0.95	0.25	0.7	10	110°	
		1.14	0.30	1.0	15	110°	
<b>No-drift Nozzle</b> AN 5	40 74 513 Blue	1.80	0.48	0.4	6	120°	
		1.90	0.50	0.7	10	120°	
		2.28	0.60	1.0	15	120°	

\*Standard equipment

Order parts and accessories from your Solo dealer.  
If there is no local dealer, use this form to order from Solo.

Part No.	Item Names/Description	Retail Price	Qty.	Total
<b>Nozzles</b>				
49 00 527	Plastic Adjustable Nozzle	\$7.95		
49 00 207	Brass Adjustable Nozzle	\$12.95		
06 10 408-P	Elbow & Nozzle Set	\$29.50		
49 00 477	Double Spray Nozzle	\$32.95		
<b>Extension tubes and spray wands</b>				
49 00 230-P	PVC Spray Wand 50cm + Nozzle	\$29.95		
49 00 513	PVC Extension Wand 50cm	\$22.95		
49 00 449	Carbon Tree Lance 120cm	\$49.50		
49 00 457	Carbon Telescopic Wand 60-120cm	\$76.50		
49 00 445	Carbon Telescopic Wand 120-230cm	\$89.95		
49 00 450	Flexible Spray Tube	\$22.95		
49 00 519	Brass Spray Wand 50cm	\$29.95		
49 00 428	Brass Spray Wand 75cm	\$29.50		
49 00 528	Brass Tree Lance 150cm	\$39.50		
49 00 478	Brass Telescopic Wand 57-100cm	\$39.50		
<b>Spray booms</b>				
49 00 514	2-Nozzle Mini Boom	\$49.50		
49 00 299	4-Nozzle Spray Boom – mounts on rear of sprayer (total width 49 3/4"; distance between nozzles 16"). Includes 4 flat spray nozzles.	\$79.50		
49 00 517	Mounting Kit for 4-nozzle boom	\$42.50		
<b>Specialty items</b>				
49 00 430	Drift Guard – Large	\$28.50		
49 00 626	Drift Guard – Small	\$9.95		
43 00 343	Heavy Duty Harness	\$59.50		
49 00 356	Pressure Gauge for Hand Piece	\$29.50		
48 00 170-P	Hand Piece Assembly	\$29.50		
27 00 316	Ball Valve Filter	\$14.95		
<b>SUBTOTAL</b>		\$		

Part No.	Item Names/Description	Retail Price	Qty.	Total
<b>Repair Kits</b>				
44 00 203	Pump Assembly – Piston	\$75.00		
44 00 221	Pump Assembly – Diaphragm	\$75.00		
06 10 407-K	425/425D/425LC Repair Kit	\$36.50		
06 10 406-K	475 Repair Kit	\$29.50		
06 10 402-K	Hand Piece Repair Kit 425/475/425LC	\$12.50		
06 10 402D	Hand Piece Repair Kit 425D	\$6.95		
<b>Miscellaneous</b>				
49 00 600	Sprayer Cleaner 500ml	\$12.95		
	<b>page 11 TOTAL</b>	\$		
	<b>page 12 TOTAL</b>	\$		
	<b>TOTAL</b>	\$		
	<b>SHIPPING CHARGE</b>	\$	10.00	
	<b>GRAND TOTAL</b>	\$		

Goods will be despatched by post within 2 working days.

Please do not send cash with this order. Make cheque payable to Clayton Investments Pty Ltd.

**Form of Payment:**     Credit Card     Cheque

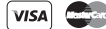

Credit Card Number     Expiration Date

Signature \_\_\_\_\_ Phone Number \_\_\_\_\_

We cannot process your credit card purchase without a signature and expiration date.

Email: \_\_\_\_\_

**PLEASE PRINT:**

Name \_\_\_\_\_

Address \_\_\_\_\_

City \_\_\_\_\_ State \_\_\_\_\_ P/Code \_\_\_\_\_

